

Article number: 2314451411

Description: E+G Cast iron wheel 451411  
RE.F4-100-RSL - loose wheel with ball bearings

## Measures

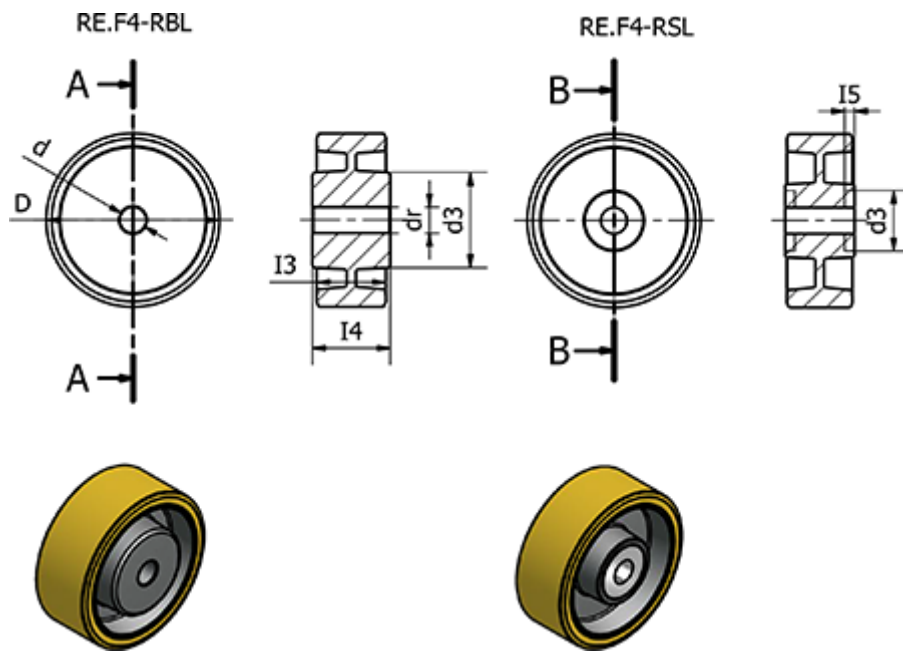

Code	= 451411	Max static load (N)	= 5000
d	= 100	Rolling resistance (N)	= 2200
d3	= 35	Type	= RE.F4-100-RSL
dr	= -	Weight (g)	= 1020
Dynamic carrying capacity (N)	= 3800		
I3	= 38		
I4	= 40		
I5	= 11		